

Alle vensterbanken zijn in de schroefkant normaal gezien voorzien van gestante slobgaten van 4,2 mm x 7,0 mm, afstand 300 mm.

De oversteek van de vensterbank uit de afgewerkte gevel moet 30-40 mm bedragen.

BUG windowsills are supplied with 4.2 mm x 7.0 mm slots punched in the screw-on section at intervals of 300 mm.

The overhang from the windowsill to the installed facade should be 30-40 mm.

Dorpeldiepte Overhang in mm	Type	VE PU m	Dorpeldiepte Overhang in mm	Type	VE PU m	Dorpeldiepte Overhang in mm	Type	VE PU m
50	201 050	36	170	201 170	36	290	201 290	12
70	201 070	36	190	201 190	36	310	201 310	12
90	201 090	36	210	201 210	24	330	201 330	12
110	201 110	48	230	201 230	24	350	201 350	12
130	201 130	48	250	201 250	24	370	201 351	12
150	201 150	36	270	201 270	24	390	201 390	12

Montagevoorbeeld met houder voor pleisterwerk

Installation example with holder for plaster facades

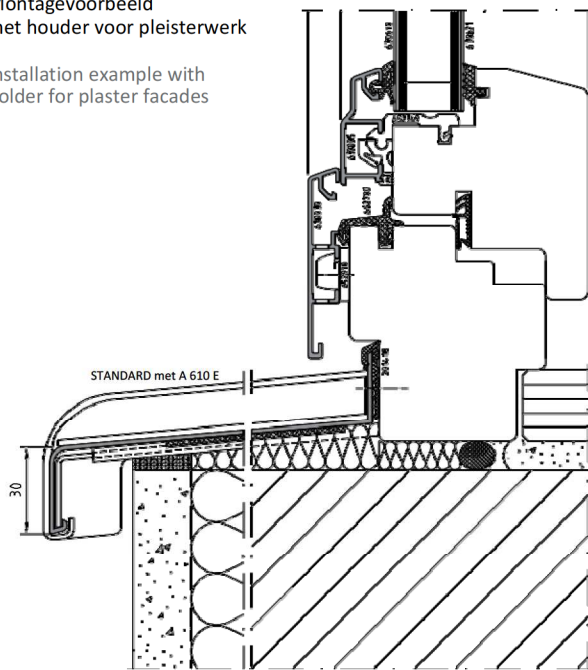

Montagevoorbeeld met houder voor gevels

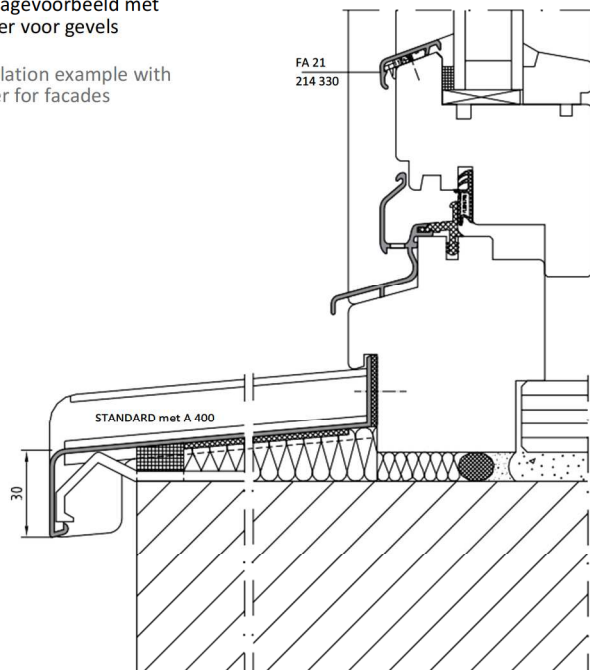

Installation example with holder for facades





Bestelnr. Beschrijving Technische gegevens	Afbeelding Afmetingen in mm	Illustration size mm	Order-No. Description Technical data
<p>A 900 G</p> <p>Glijdend alu/kunststof eindstuk voor diepte van 110-390 mm</p> <p>Aanbevolen voor ETICS-gevels</p> <p>Uitzetting per zijde +2 mm/-1 mm</p> <p>VE 30 stuks</p>			<p>A 900 G</p> <p>Slip-on aluminium glide end cap for overhangs of 110-390 mm</p> <p>Recommendation for ETICS facades</p> <p>Thermal expansion each side +2 mm/-1 mm</p> <p>PU 30 pcs.</p>
<p>A 400 / 22</p> <p>Compact eindstuk voor pleistergevels links/rechts voor diepte van 50-390 mm</p> <p>VE 30 stuks</p>			<p>A 400 / 22</p> <p>Compact end cap for plaster facades left/right for overhangs of 50-390 mm</p> <p>PU 30 pcs.</p>
<p>A 450</p> <p>Compact eindstuk voor gevels links/rechts voor diepte van 50-390 mm</p> <p>VE 30 stuks</p>			<p>A 450</p> <p>Compact end cap for facades left/right for overhangs of 50-390 mm</p> <p>PU 30 pcs.</p>
<p>A 500 V / 24</p> <p>Glijdend alu/kunststof eindstuk voor diepte van 150-390 mm</p> <p>Aanbevolen voor ETICS-gevels</p> <p>Uitzetting per zijde +2 mm/-1 mm</p> <p>VE 30 stuks</p>			<p>A 500 V / 24</p> <p>Slip-on aluminium glide end cap for overhangs of 150-390 mm</p> <p>Recommendation for ETICS facades</p> <p>Thermal expansion each side +2 mm/-1 mm</p> <p>PU 30 pcs.</p>
<p>A 500 V / 34</p> <p>Glijdend alu/kunststof eindstuk voor diepte van 150-390 mm</p> <p>Aanbevolen voor ETICS-gevels</p> <p>Uitzetting per zijde +2 mm/-1 mm</p> <p>VE 30 stuks</p>			<p>A 500 V / 34</p> <p>Slip-on aluminium glide end cap for overhangs of 150-390 mm</p> <p>Recommendation for ETICS facades</p> <p>Thermal expansion each side +2 mm/-1 mm</p> <p>PU 30 pcs.</p>

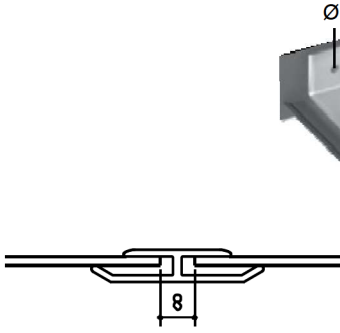
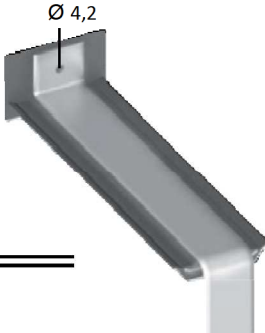
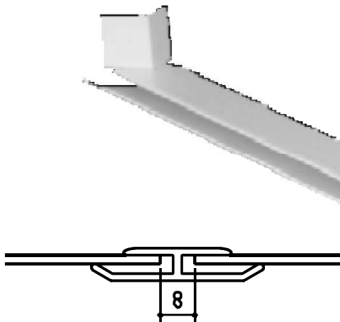
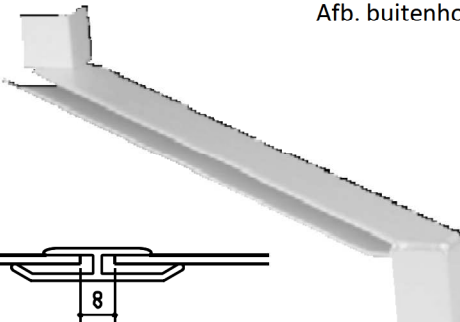
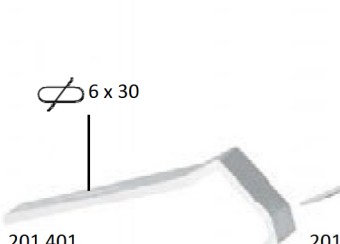
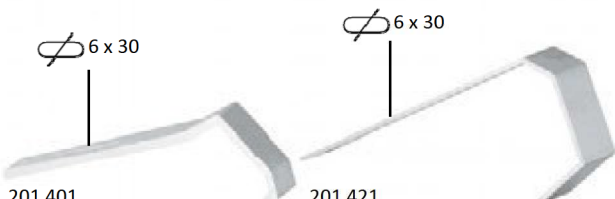
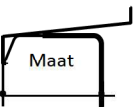
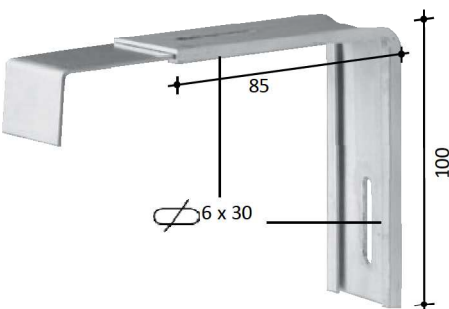
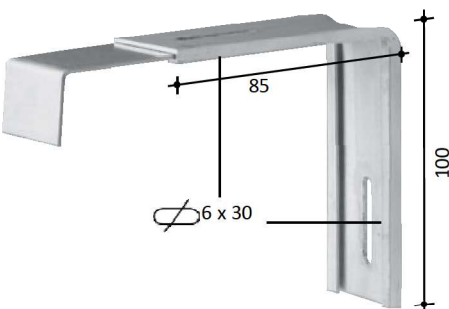

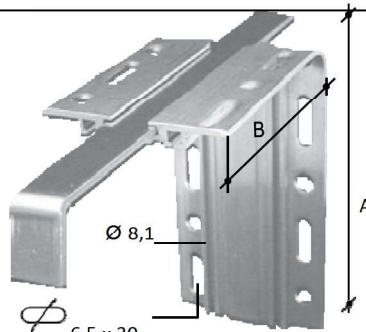
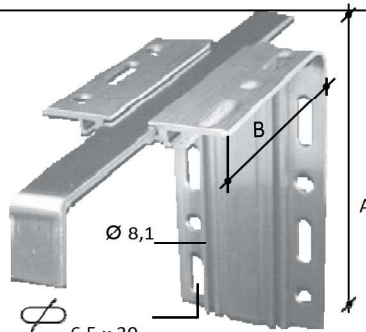
Bestelnr. Beschrijving Technische gegevens	Afbeelding Afmetingen in mm	Illustration size mm	Order-No. Description Technical data
<p>H 500 D</p> <p>Regendichte stootverbinding voor diepte van 50-390 mm</p> <p>1950 Pa, ift-getest</p> <p>VE 10 stuks</p>			<p>H 500 D</p> <p>Joint Connector, rain proof for overhangs of 50-390 mm</p> <p>1950 Pa</p> <p>PU 10 pcs.</p>
<p>H1-stootverbinding voor binnen- en buitenhoeken 90° en 135°</p> <p>voor diepte van 50-390 mm</p> <p>VE 10 stuks</p>		<p>Afb. buitenhoek</p> 	<p>H1 Corner joint connector for internal and external corners 90° and 135°</p> <p>for overhangs 50-390 mm</p> <p>PU 10 pcs.</p>
<p>Houder voor gevel 201 401</p> <p>VE 20 stuks</p> <p>Houder voor pleistergevel 201 421</p> <p>VE 20 stuks</p>			<p>Holder for facades 201 401</p> <p>PU 20 pcs.</p> <p>Holder for plaster facades 201 421</p> <p>PU 20 pcs.</p>
<p>Vensterbankhouder 201 842</p> <p>verstelbaar van 90-120 mm</p> <p>VE 10 stuks</p>	  <p>Houder draaien naar behoefte Turn holder as required</p>		<p>Holder for ETIC Systems 201 842</p> <p>adjustable from 90-120 mm</p> <p>PU 10 pcs.</p>
<p>Vensterbankhouder</p> <p>verstelbaar van</p> <p>201 841 120-220 mm</p> <p>201 843 230-300 mm</p> <p>201 844 310-390 mm</p> <p>201 841 A 130 / B 95</p> <p>201 843 A 150 / B 210</p> <p>201 844 A 150 / B 290</p> <p>VE 10 stuks</p>	  <p>Houder draaien naar behoefte Turn holder as required</p>		<p>Holder for ETIC Systems adjustable from</p> <p>201 841 120-220 mm</p> <p>201 843 230-300 mm</p> <p>201 844 310-390 mm</p> <p>201 841 A 130 / B 95</p> <p>201 843 A 150 / B 210</p> <p>201 844 A 150 / B 290</p> <p>PU 10 pcs.</p>